

laser diode module, elliptical beam, \varnothing 12mm

A compact, ergonomically-designed 830nm laser diode module for a wide range of applications such as industrial alignment, positioning and inspection and sensing.

Laser diode modules from the Optoelectronics Company are available in wavelengths from 405nm to 852nm, in a wide range of optical output powers to customer specifications.

specifications (typical figures at 25° C)

part number	500-010009	500-010010
wavelength (nm)	830	830
power (mW)	20.0	35.0
typ. operating current (mA)	60	80
power stability	<5%	<5%
pointing stability	<0.2mrad/°C	<0.2mrad/°C
bore sighting	<2.0°	<2.0°
operating voltage	3.0 – 6.0V DC	3.0 – 6.0V DC
beam diameter (mm)	4 x 2	4 x 2
beam divergence (mrad)	0.6 x 0.3	0.6 x 0.3
operating temperature (non-condensing)	-10°C to +50°C	-10°C to +50°C
storage temperature	-40°C to +85°C	-40°C to +85°C
housing material	Anodised Aluminium	Anodised Aluminium



key features

- Externally adjustable optics with lock ring
- Self-contained drive electronics
- Panasonic glass lens
- Coloured end caps for easy identification
- High reliability
- Compact, ergonomic design
- Laser engraving available on request (e.g. your part number)
- Other output powers available on request

applications

- Industrial alignment
- Positioning
- Industrial inspection
- Sensors

laser diode module, elliptical beam, $\varnothing 12\text{mm}$

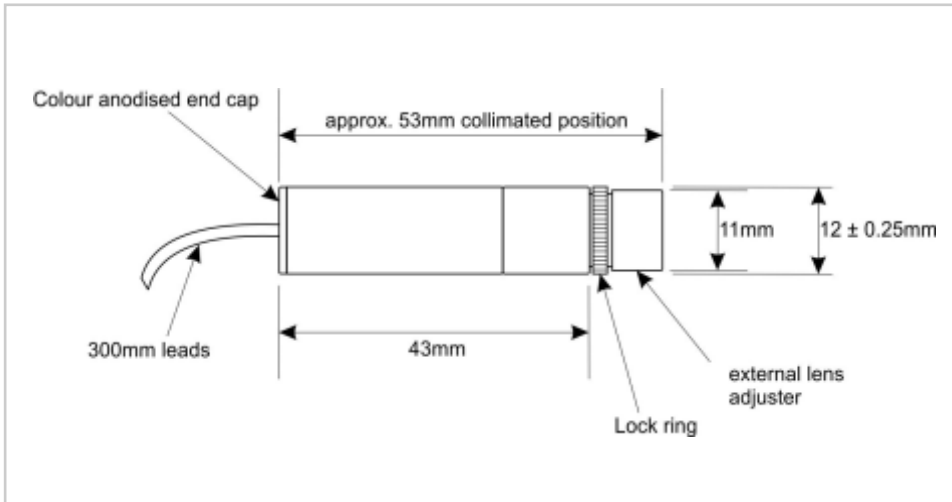

warranty

All Laser Diode Modules are covered by a two year warranty. Specifications subject to change without notice. E&OE.

laser safety

LASER APERTURE	LASER APERTURE	LASER APERTURE	LASER APERTURE
<p>LASER RADIATION DO NOT STARE INTO BEAM CLASS 2 LASER PRODUCT MAX. POWER: 1mW WAVELENGTH: 400 - 695nm COMPLIES WITH IEC60825-1 2001</p>	<p>LASER RADIATION AVOID EXPOSURE TO BEAM CLASS 3B LASER PRODUCT MAX. POWER: 500mW WAVELENGTH: 315 - 700nm COMPLIES WITH IEC60825-1 2001</p>	<p>INVISIBLE LASER RADIATION AVOID EXPOSURE TO BEAM CLASS 3B LASER PRODUCT MAX. POWER: 500mW WAVELENGTH: 700 - 980nm COMPLIES WITH IEC60825-1 2001</p>	<p>LASER RADIATION AVOID DIRECT EYE EXPOSURE CLASS 3R LASER PRODUCT MAX. POWER: 5mW WAVELENGTH: 400 - 695nm COMPLIES WITH IEC60825-1 2001</p>

The light emitted from these devices has been set in accordance with IEC60825. However, staring into the beam, whether directly or indirectly, must be avoided. IEC60825 classifies laser products into 3 categories depending on light emitted, wavelength and eye safety.

CLASS II: "CAUTION" : visible laser light less than 1.0mW. Considered eye-safe, normal exposure to this type of beam will not cause permanent damage to the retina.

CLASS II IR: "DANGER" : visible laser light between 1.0mW and 5.0mW. Considered eye-safe with caution. Focussing of this light into the eye could cause some damage.

CLASS III B: "DANGER" : infrared (IR) and high power visible lasers considered dangerous to the retina if exposed.

Heat Sinking

Please note that premature or sudden catastrophic laser diode failure may occur if the maximum operating temperature is exceeded. For optimal laser diode lifetime we recommend our laser diode modules are provided with an additional form of external heatsinking. The lower the operating temperature of the laser diode, the longer will be its lifetime.

NB: Please note that while complying with the above classifications, unless otherwise stated, our laser diode products are not certified and are designed solely for use in OEM products. The way in which the device is used in the final product may alter its original design classification, and it is the responsibility of the OEM to ensure compliance with the relevant standards.